

# Zapah i

## PREČNI ZAPAH

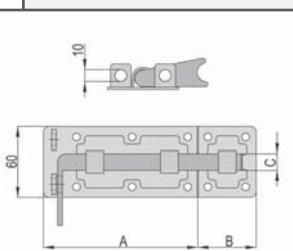

Artikel	A	B	C
<b>CT5/180</b>	130	50	14

Prečni zapah iz pocinkanega železa za obešanko.

## PREČNI ZAPAH

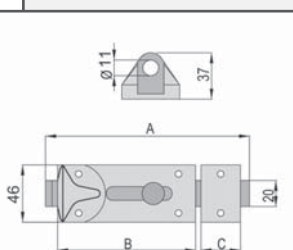

Artikel	A	B	C
<b>CT6/150</b>	150	105	31

Prečni zapah iz pocinkanega železa za obešanko.

## PREČNI ZAPAH

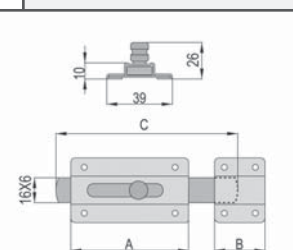

Artikel	A	B	C
<b>CT8/Z-90</b>	100	50	150

Prečni zapah iz pocinkanega železa s prejemnikom.

## PREČNI ZAPAH

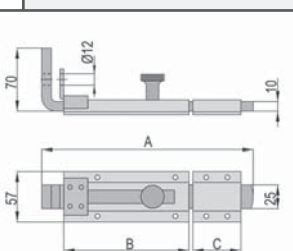

Artikel	A	B	C
<b>CT10/Z-300</b>	300	210	80

Prečni zapah iz pocinkanega železa za obešanko.

# Ključavničarsko okovje

## PREČNI ZAPAH

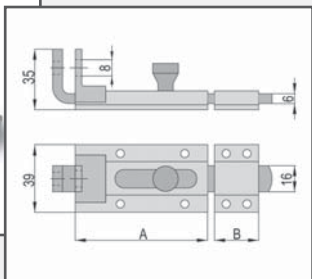
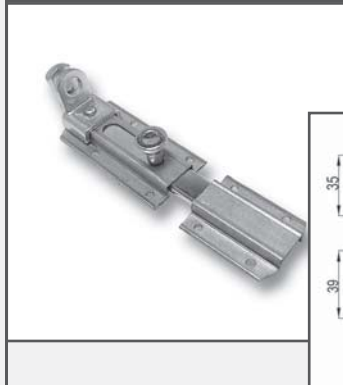

Artikel	A	B
<b>CT11/Z-130</b>	80	40

Prečni zapah iz pocinkanega železa za obežanko.

## VERTIKALNI ZAPAH

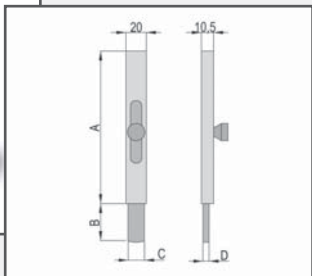

Artikel	A	B	C	D
<b>CV616/150</b>	150	50	16	6
<b>CV616/300</b>	300	50	16	6

Vertikalni zapah iz pocinkanega železa za varit.

## VERTIKALNI ZAPAH

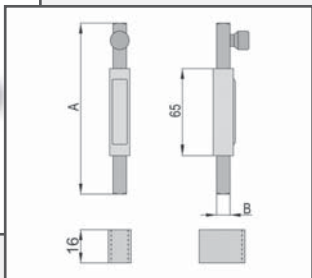

Artikel	A	B
<b>CV10/130</b>	130	10

Vertikalni zapah iz pocinkanega železa s kvadratno konico in prejemnikom.

## VERTIKALNI ZAPAH

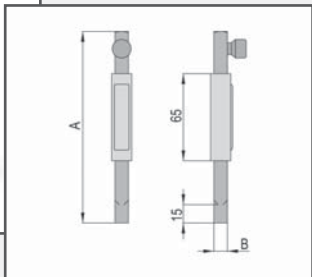

Artikel	A	B
<b>CV10/T130</b>	130	9

Vertikalni zapah iz pocinkanega železa z okroglo konico.

## VERTIKALNI ZAPAH

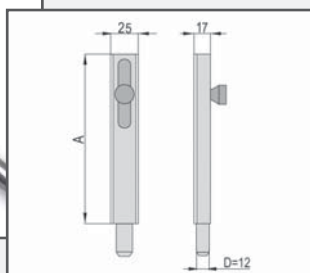

## Artikel

## A

CVS/T150

150

CVS/T300

300

Vertikalni zapah za privarit iz pocinkanega železa z okroglo konico.

## VERTIKALNI ZAPAH

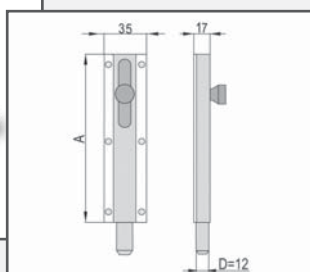

## Artikel

## A

CVF/t150

150

CVF/T300

300

Vertikalni zapah za privijačit iz pocinkanega železa z okroglo konico.

## VDOLBNI ZAPAH

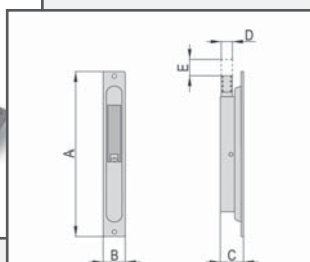

## Artikel

## A

## B

## C

## D

## E

CL20Z

152

20

20

M8

15

Vdolbni zapah z enostranskim zapiranjem.

## VDOLBNI ZAPAH

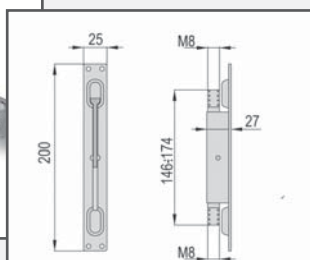

## Artikel

CL24ZD/N

Vdolbni zapah z dvostranskim zapiranjem.

## VRATNI ZAPAH

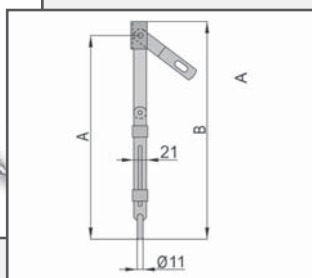

Artikel

A

B

PL600

605

630

Vratni zapaž iz pocinkanega železa za zapiranje sekundarnega krila.

## SAMOZAPIRALNI ZAPAH

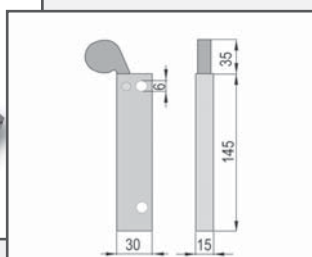

Artikel

PAM

Samozapiralni zapaž iz nerjavečega jekla za zapiranje sekundarnih kril pri večkrilnih vratih.

## VRATNI ZAPAH

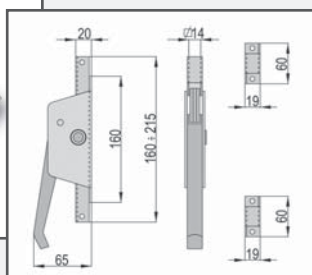

Artikel

CAR/Z

Vratni zapaž iz pocinkanega železa za zapiranje sekundarnih kril pri večkrilnih vratih.

## VRATNI ZAPAH

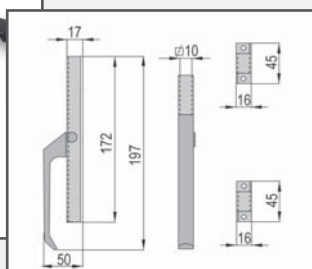

Artikel

CAR/C

Pocinkan vratni zapaž v črni barvi za zapiranje sekundarnih kril pri večkrilnih vratih.